

HAVA KANALI SAC BÜKÜMÜ
1200X2400X2-İMİALAT ADET:38ADET-1927KG/42TBK

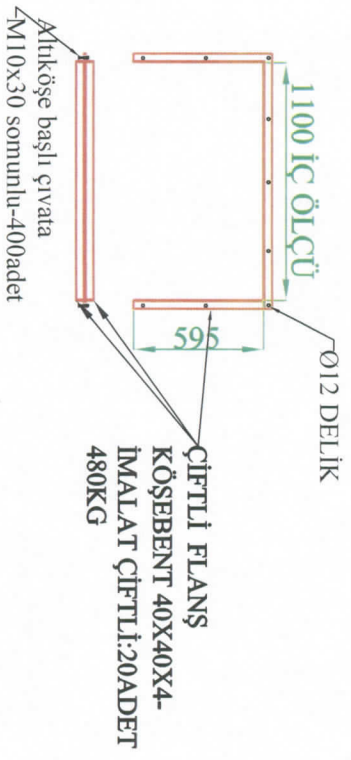
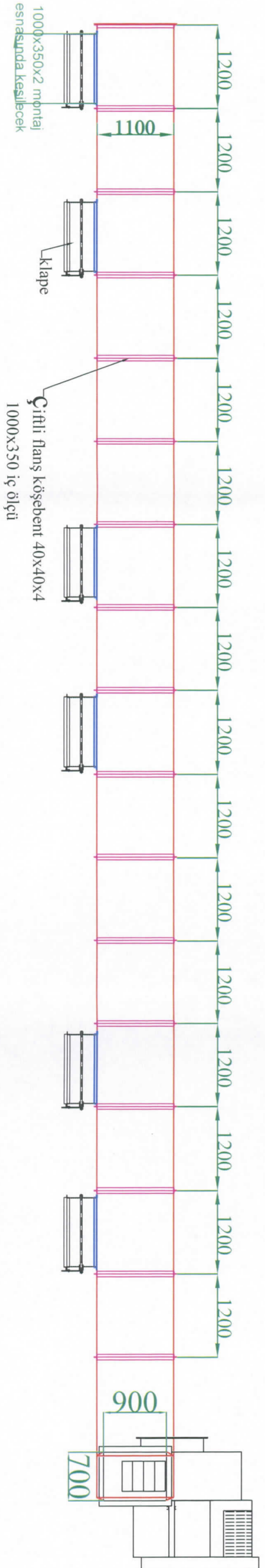

ÇİFTLİ FLANŞ
KÖŞEBENT 40X40X4-
İMİALAT ÇİFTLİ:20ADET
480KG

Atıköşe başlı çivata
M10x30 somunlu-400adet

Çizen	Tarih	Ad Soyad	İmza	Onay
Mak.Et.P.Şb.Md.		Selami COŞKUN		Bayram SEKMEN Makina Daire Başkanı
Makina Şb.Müd.		Orhan YAVUZ	<i>[Signature]</i>	
		Selahattin EYÜBOĞLU		
HAYRAT ÇAY FABRİKASI ÖN SÖLDIRMAALT KAT HAVA BAŞMA KANALI İMLAT RESİMLERİ				
Ölçek			Resim No	2018-10

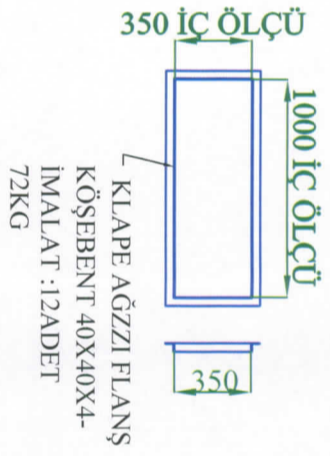
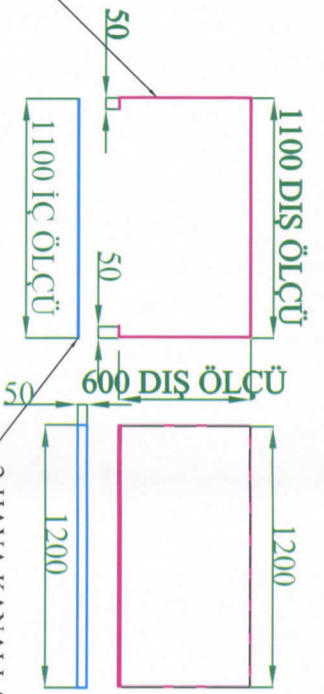
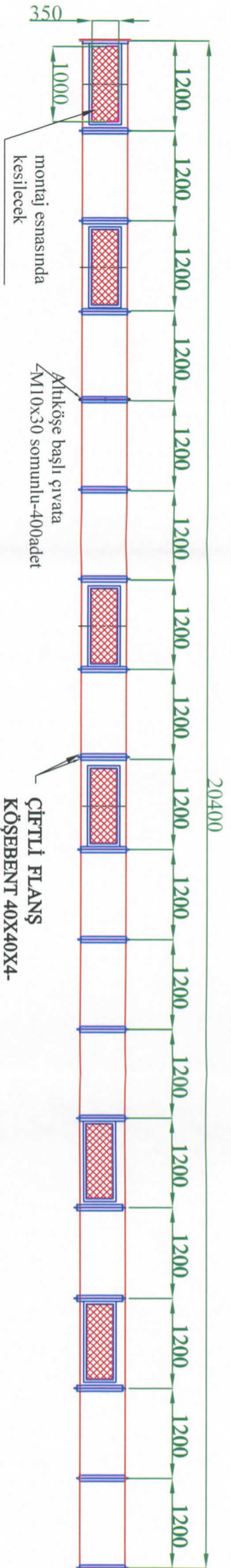

4-HAVA KANALI SAC BÜKÜMÜ
1200x2400x2-İMALAT ADET:34ADET-34TABAK-1560KG

2-HAVA KANALI ALT SACI
1200x2400x2-İMALAT ADET:34ADET-780KG

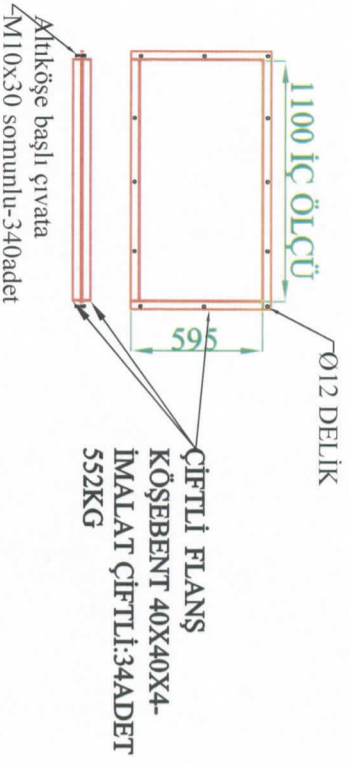
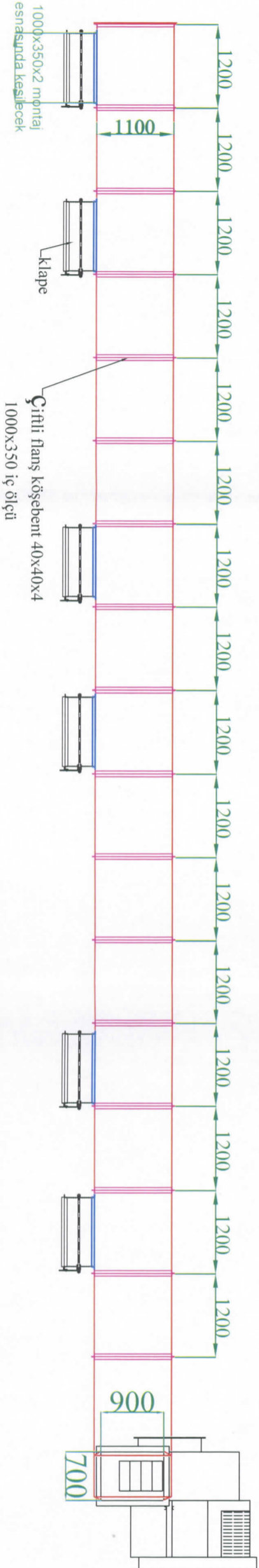

Çizen	Tarih	Ad Soyad	İmza	Onay
Mak. Et. P. Şb. Md.		Selami COŞKUN		Onay <i>Selami Coşkun</i>
Makina Şb. Müd.		Orhan YAVUZ	<i>Orhan Yavuz</i>	
		Selahattin EYÜBOĞLU		Bayram SEKMEN Makina Daire Başkanı
Ölçek	HAYRAT ÇAY FABRİKASI ÖN SÖLDÜRME ÜST KAT HAVA BASMA KANALI İMALAT RESİMLERİ			Resim No 2018-11

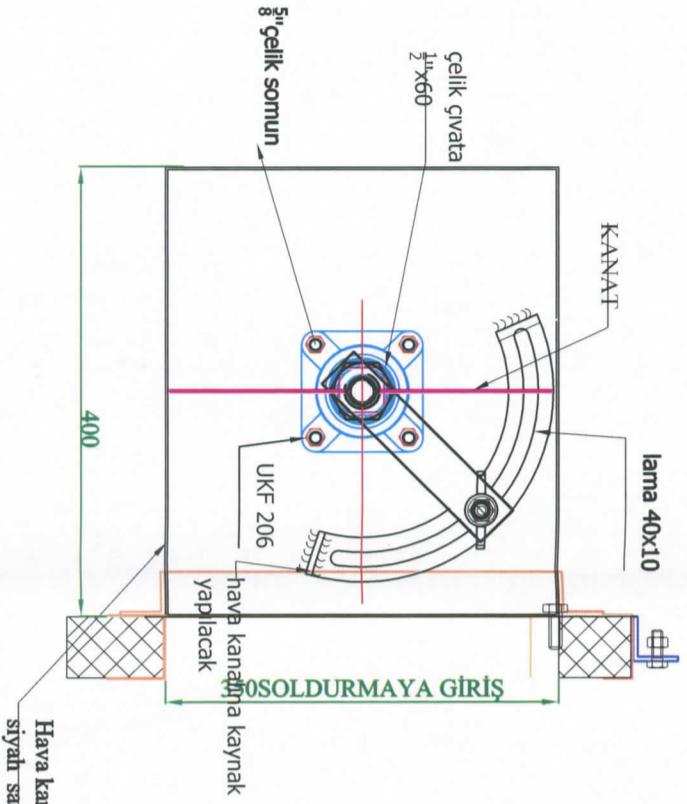

HAVA KANALI KALAPESİ(24ADET)

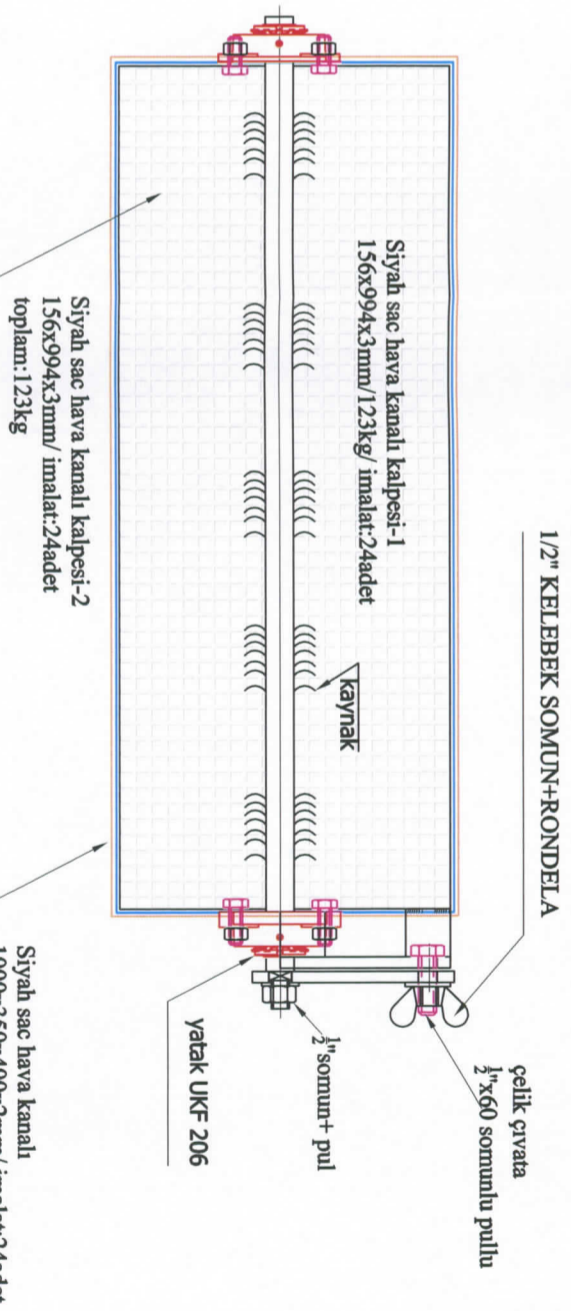

KANAT SIYAH SAC
1000x200x3
KANATI:160x96x3
İMALAT:24 ADET
91kg

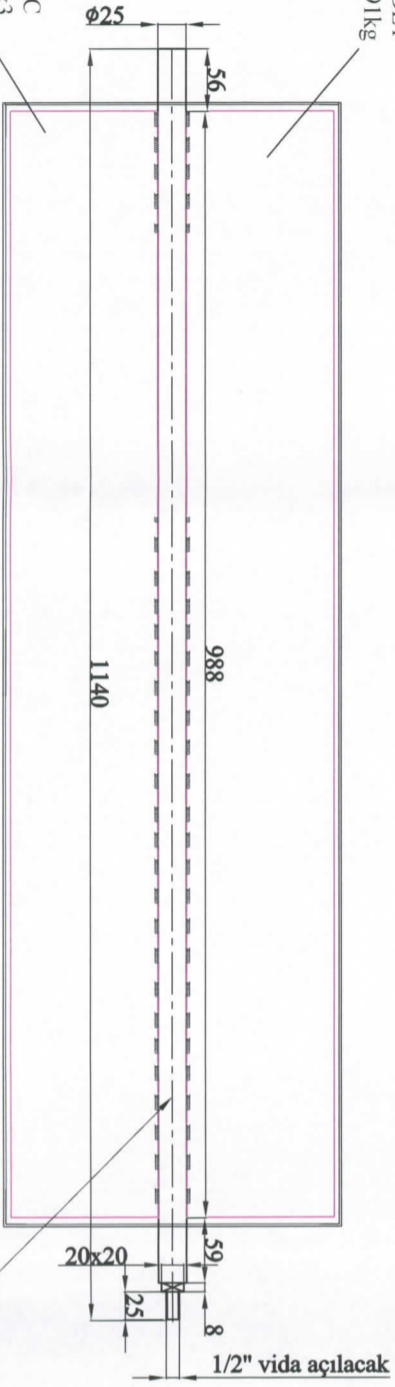

MİL.-Ø25X1137
İMALAT:24ADET

KOL KANAL LAMASI -40X10X389
İMALAT:24ADET

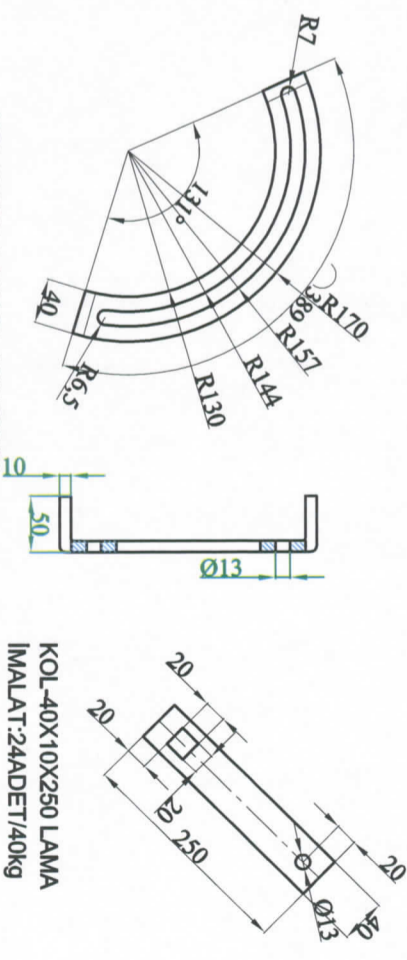

KOL-40X10X250 LAMA
İMALAT:24ADET/40kg

HAVA KANALI KALAPESİ İMALAT RESİMLERİ (24ADET)

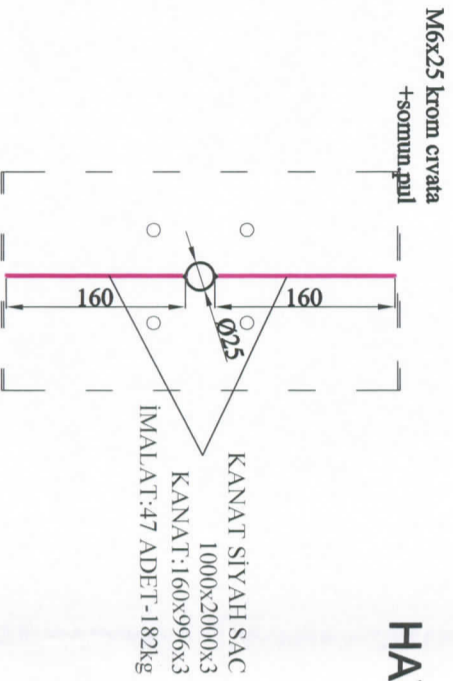

KANAT SIYAH SAC
1000x200x3
KANAT:160x96x3
İMALAT:47 ADET-182kg

M6x25 krom çivata
+somun+ pul

Çizen	Tarih	İsim	İmza
Etiit Prj.Md.		Selami COŞKUN	
Makina Müd.		Orhan YAVUZ	
Miz.Pln.Müd.		S. EYÜBOĞLU	
ÖLÇEK			

HAYRAT ÇAY FABRİKASİON SOLDURMA
HAVA KANALI KLAPESİ İMALATI

Resim no
2018-12

Araslanlı.

Bayram SEKMEN
Makina Dairesi Başkanı



HAVA KANALI ALT KAT ÖN SACI

Galvanizli sac 300x2260x1,5mm

imalat: 12adet-72adet sacdan arta kalan 400mm sacın
-12adedi bu ölçülerde kesilecek.



HAVA KANALI ÜST ÖN SACI

Galvanizli sac 400x2260x1,5mm

imalat: 12adet-72adet sacdan arta kalan 400mm sacın
-12adedi bu ölçülerde kesilecek.

imalat: 145adet(BÖLÜM1-2)

145 tabak sacı **73adet tabaktan arta kalan 400mm tekrar**
ikiye bölünecek -geriye kalan 72adet tabaktan arta kalan
400mm ortadan bölünmeden fabrikasına geri verilecek.

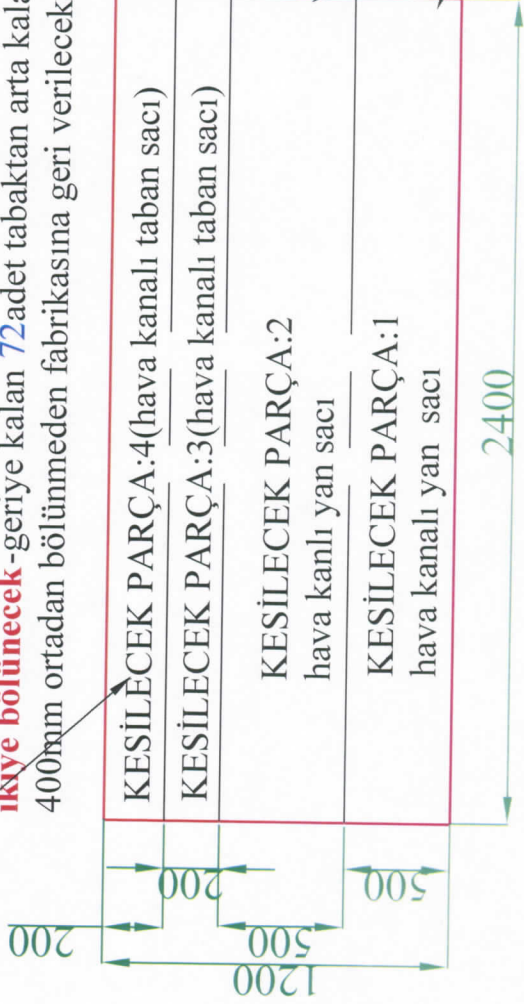

imalat:
287adet

Galvanizli sac 1200x2400x1,5mm
145tabak/5000kg(BÖLÜM1-2)

Anatemiir.

SABUNCULAR	Tarih	İsim	İmza	Onay	Malzeme	Resim No
Çizen	26.01.2017	Tuncay HÜYÜK				2018-9
Mak. Et. P. Şb. Md.		Orhan YAVUZ				
Makina Şb. Müd.		Selahattin EYÜBOĞLU				
Ölçek	Parça Adı					
Ağırlık	HAYRAT ÇAY FABRİKASI ÖN SOLDURMA					
İmalat Adet	HAVA KANALI GALV.SACI KESİM İMALATI					

Bayram SEKMEN
Makina Daire Başkanı

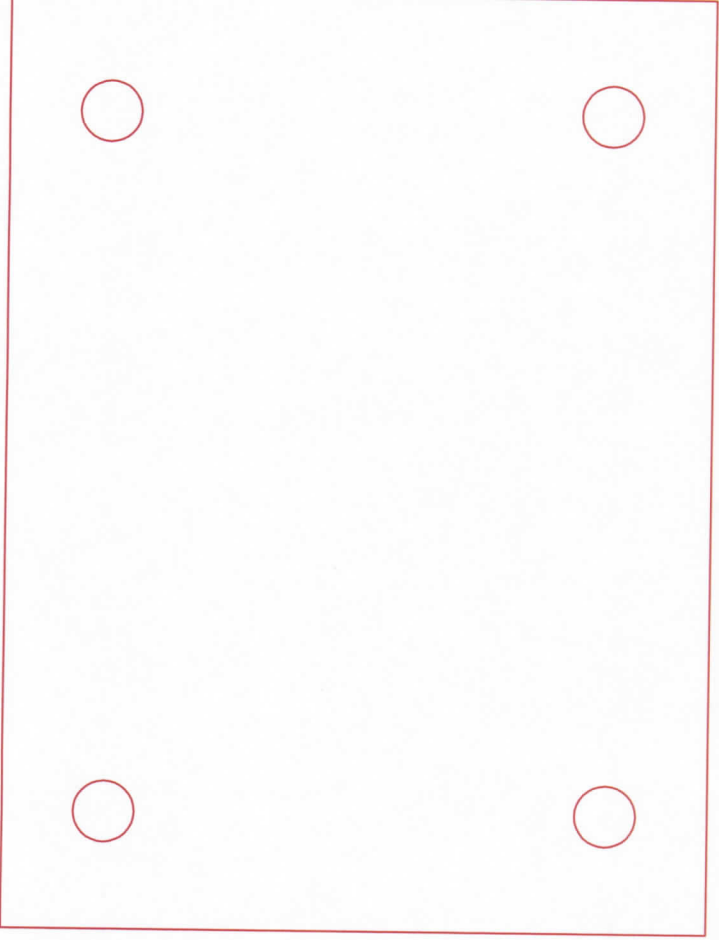

ZEMİN PLAKASI 1500X6000X6MM
İMALAT:150X200X6:175ADET/250KG

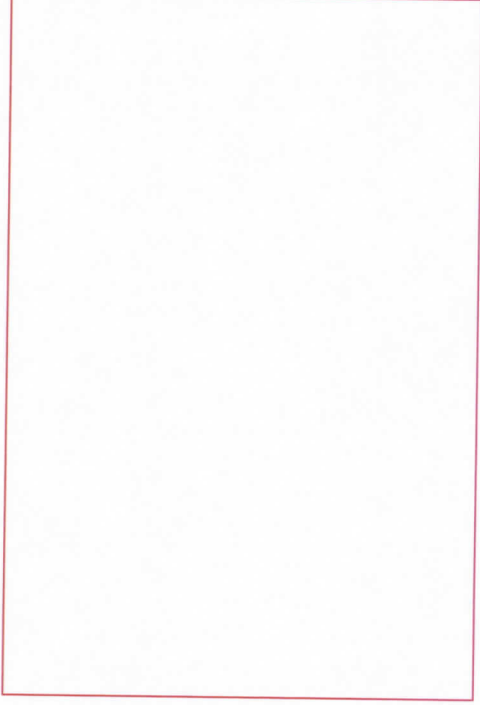

MEVCUT TEKNE ÜSTÜ PLAKASI 1500X6000X6MM
İMALAT:150X100X6: 190ADET/136KG

Shafak

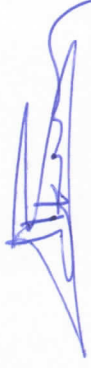
Çizen	Tarih	Ad Soyad	Onay
Mak.Et.P.Şb.Md.		Selami COŞKUN	 Bayram SEKMEN Makina Daire Başkanı
Makina Şb.Müd.		Orhan YAVUZ	
Ölçek		Selahattin EYÜBOĞLU	
HAYRAT ÇAY FABRİKASI SAC PLAKA KESİM RESMİ			Resim No 2018-8

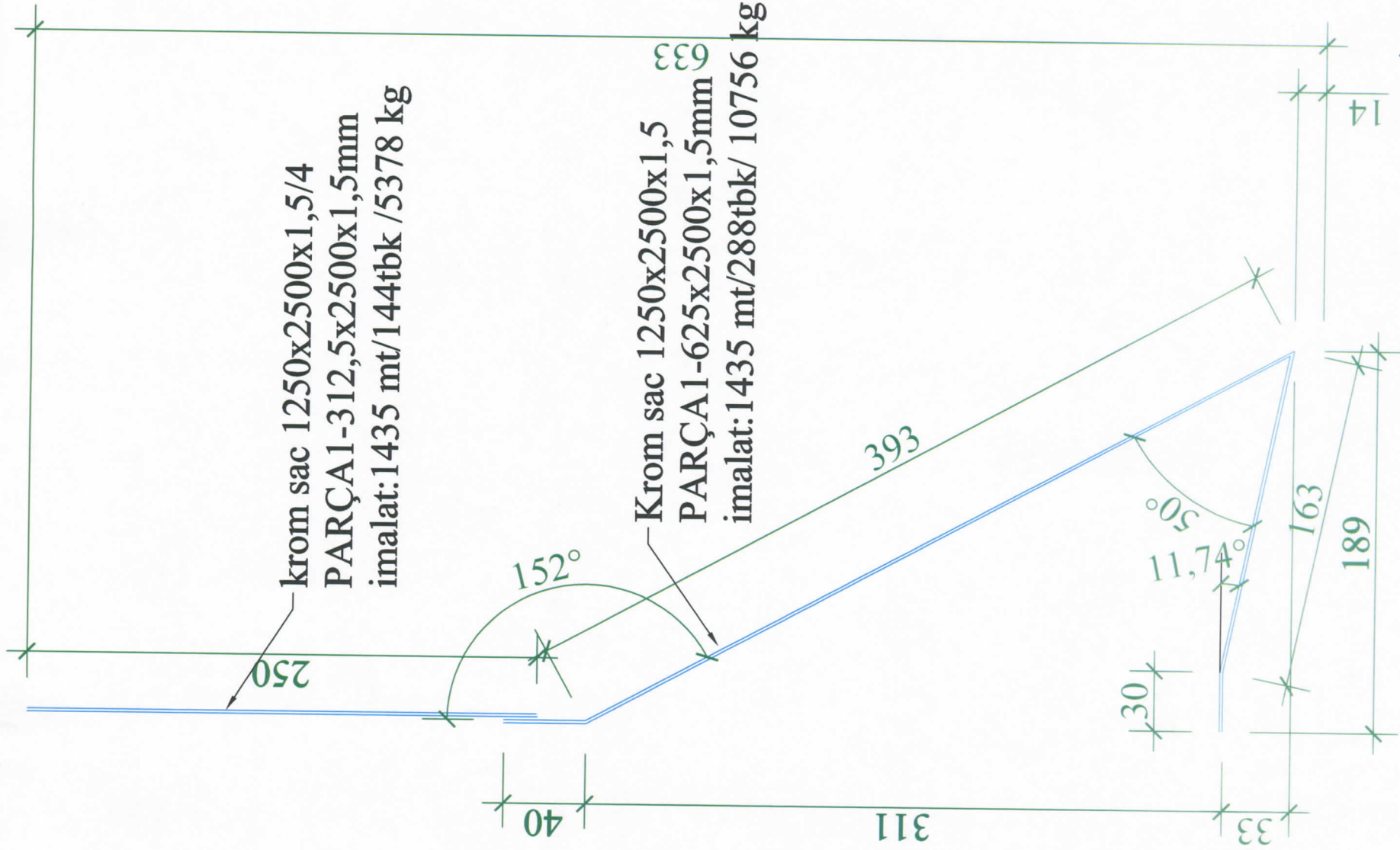

Anatemi.r.

Çizen	Tarih	Ad Soyad	İmza	Onay
Mak.Et.P.Şb.Md.		Selami COŞKUN		 Bayram SEKMEN Makina Daire Başkanı
Makina Şb.Müd.		Orhan YAVUZ		
Ölçek		Selahattin EYÜBOĞLU		
HAYRAT ÇAY FABRİKASI				Resim No
SÜPÜRGE LİK S A C I İ M A L A T R E S M İ				2018-7